

When it comes to web video SIZE DOES MATTER!

At high print speeds, it is impossible to accurately examine the print repeat with conventional web viewing systems. Common print defects that are easily overlooked by operators:



Registration



Streaks



Missing print

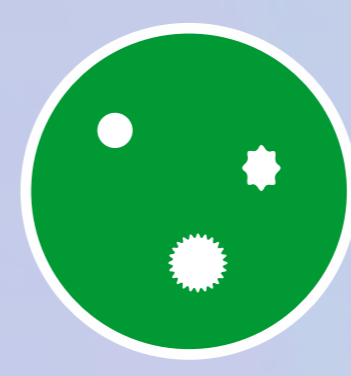

Drags and holes

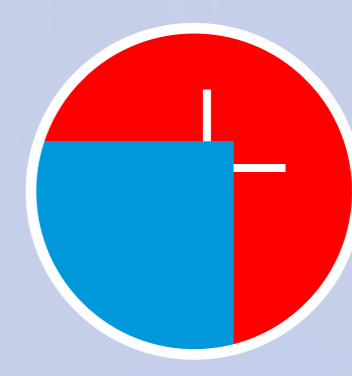

Bleeding

ViewAXIS Tera

The first full print repeat web viewing system for superior web viewing



Print repeat is only partially visible on conventional web viewing system

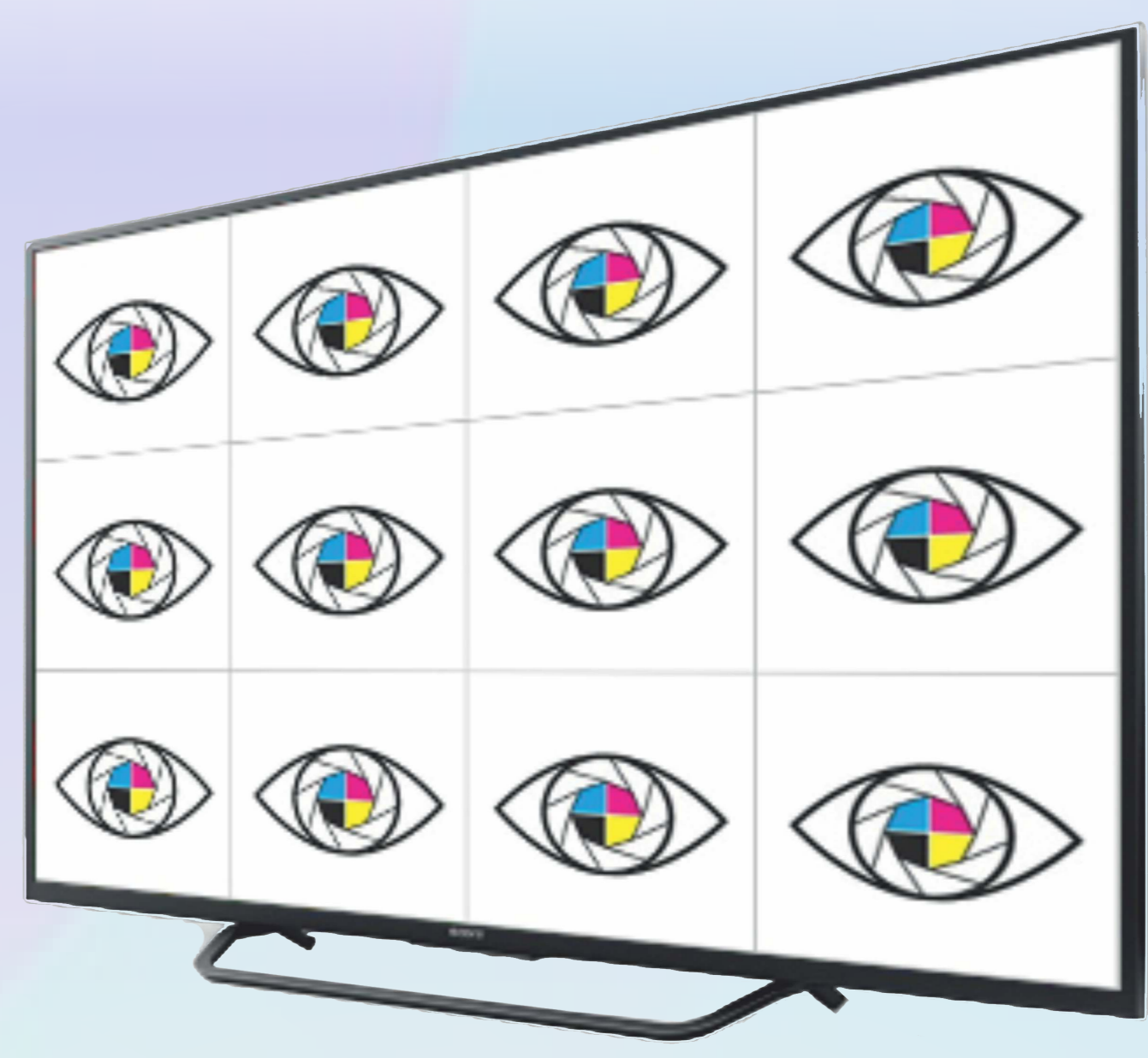

Full print repeat is visible on ViewAXIS Tera

Features



55" 4K monitor for full print repeat monitoring



Numerous image control options



22" HD monitor for visualising specific portion of the web



Easy and quick access to all portions of the repeat at a time



Split screen function for comparison of both edges



Automatic scanning of critical areas

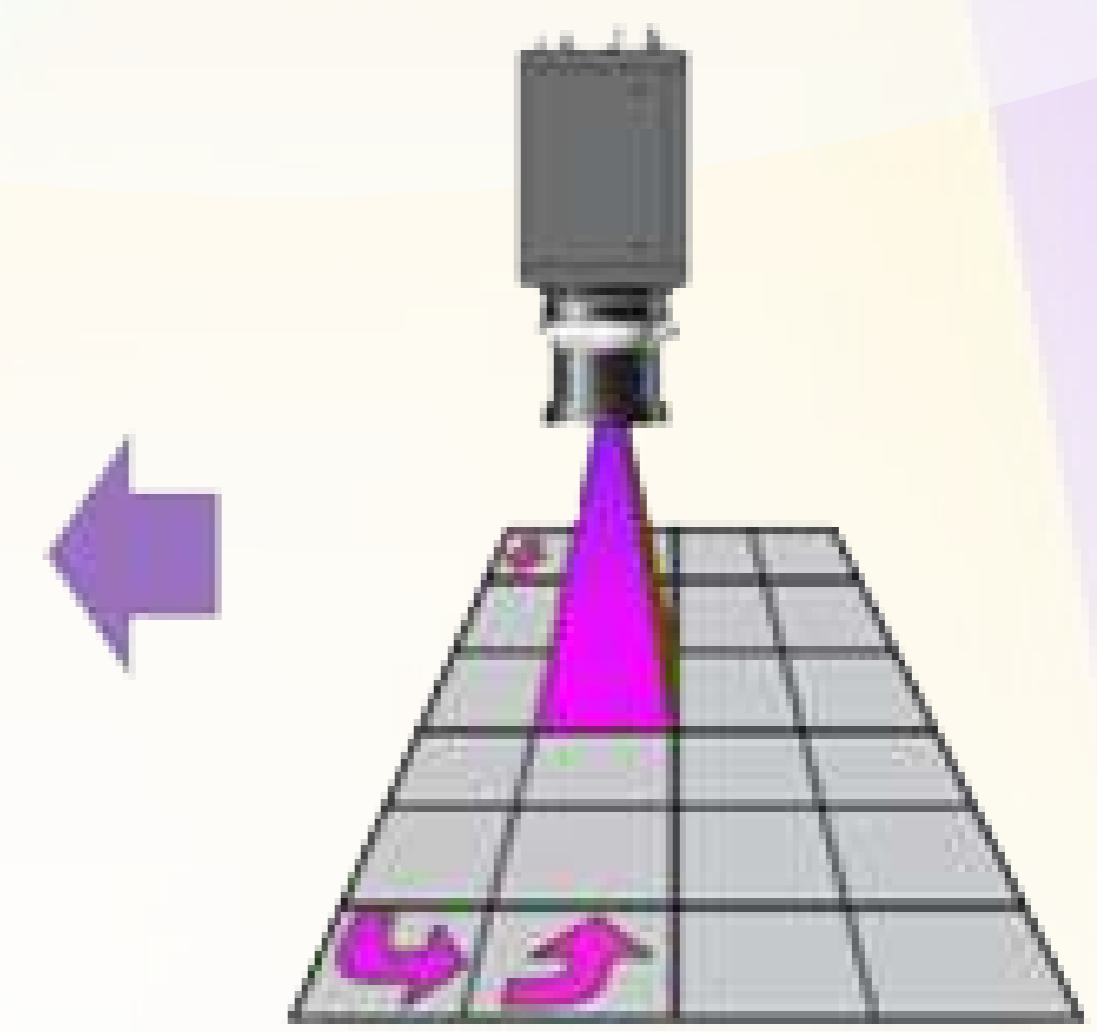
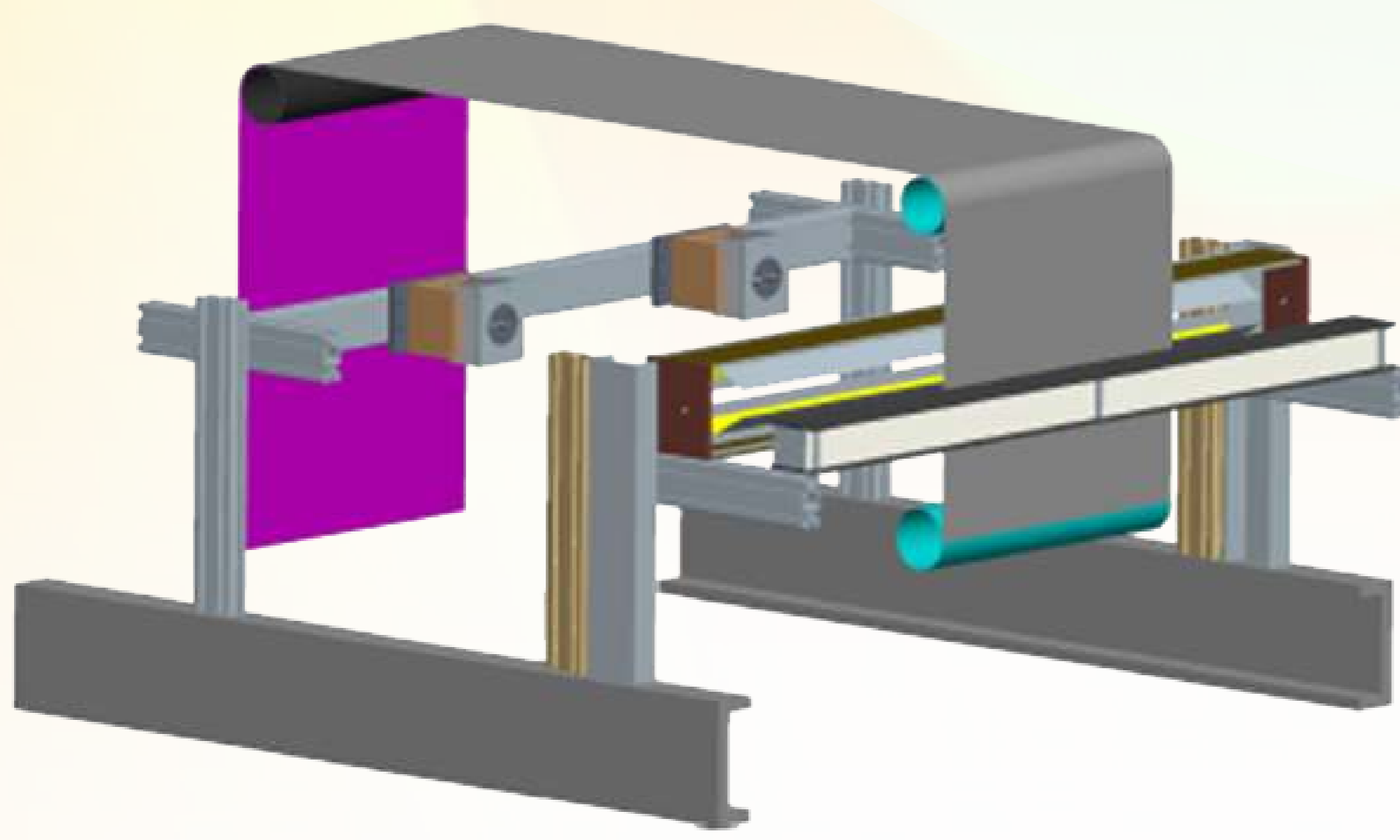

Image resolution equivalent to 50+ megapixels



Repeat scan mode and selection of critical areas

Line scan camera produces high resolution images of fast moving substrates



Process flow diagram

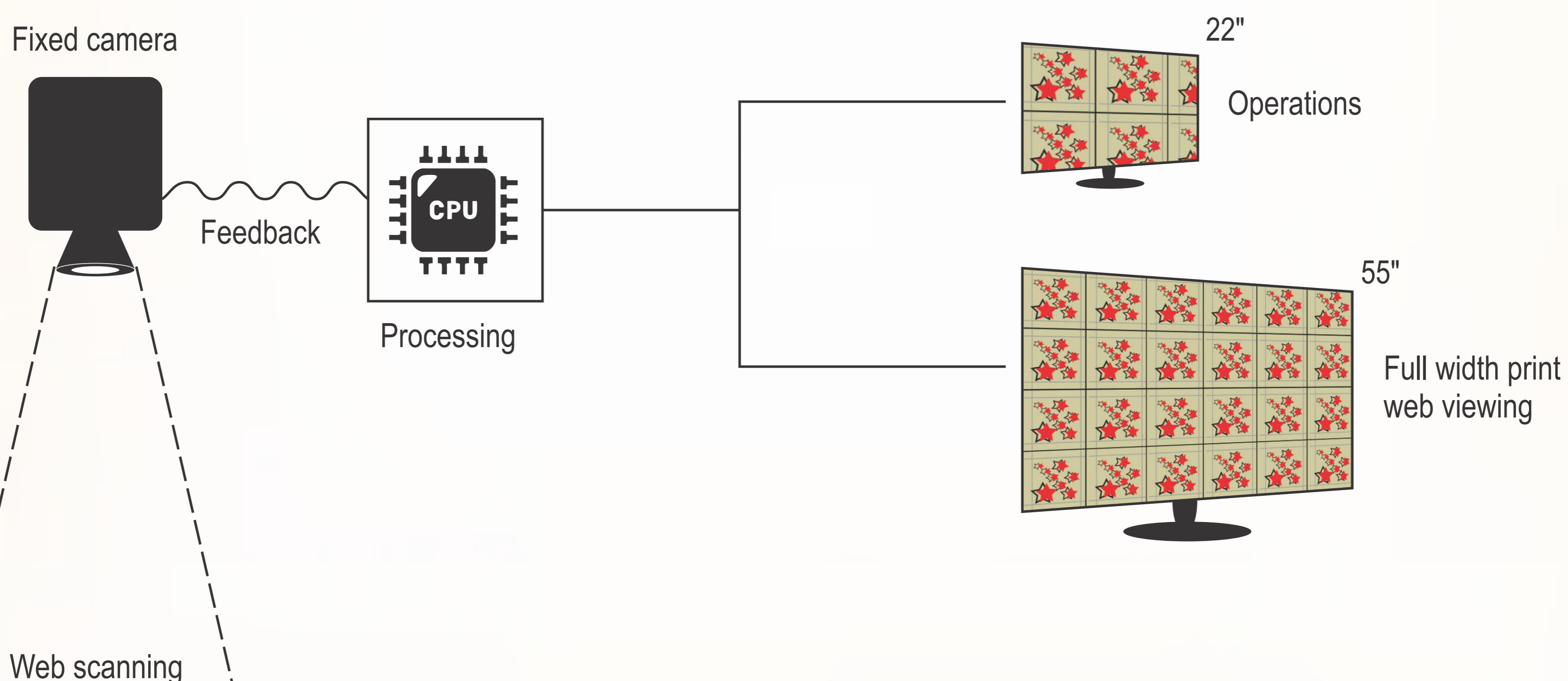

Benefits

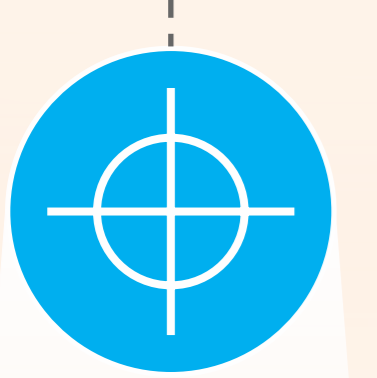

Precise and efficient web monitoring



Captures high resolution near print quality images



Superior output print quality

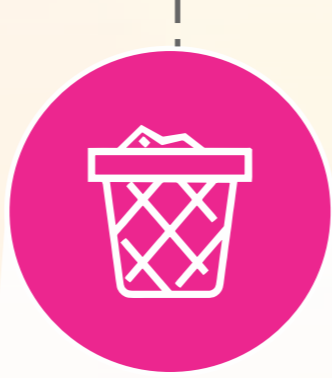

Reduced material rejection



Improved productivity



Easy to operate with intuitive GUI



Online diagnostics and support



Improved profit