

# Pyxis<sup>®</sup>

## ST-772 Series Dissolved Oxygen Sensor User Manual



Water Professionals Deserve Better Tools.  
[www.pyxis-lab.com](http://www.pyxis-lab.com)

# ST-772 Series Dissolved Oxygen Sensor User Manual

February 16, 2021  
Rev. 1.04

**Pyxis Lab, Inc.**  
1729 Majestic Dr. Suite 5  
Lafayette, CO 80026 USA  
[www.pyxis-lab.com](http://www.pyxis-lab.com)

## Table of Contents

<b>1</b>	<b>Introduction</b>	<b>2</b>
1.1	Main Features . . . . .	3
<b>2</b>	<b>Specifications</b>	<b>4</b>
<b>3</b>	<b>Unpacking Instrument</b>	<b>6</b>
3.1	Standard Accessories . . . . .	6
3.2	Optional Accessories . . . . .	7
<b>4</b>	<b>Installation</b>	<b>8</b>
4.1	Submersed Floating Installation . . . . .	8
4.2	Submersed Fixed Installation . . . . .	9
4.3	Pipeline Installation . . . . .	10
4.4	Wiring . . . . .	11
4.5	Connecting via Bluetooth . . . . .	11
<b>5</b>	<b>Setup and Calibration with uPyxis® Mobile App</b>	<b>12</b>
5.1	Download uPyxis® Mobile App . . . . .	12
5.2	Connecting to uPyxis® Mobile App . . . . .	13
5.3	Calibration Screen and Reading . . . . .	14
5.4	Diagnosis Screen . . . . .	15
5.5	Device Info Screen . . . . .	16
<b>6</b>	<b>Setup and Calibration with uPyxis® Desktop App</b>	<b>16</b>
6.1	Install uPyxis® Desktop App . . . . .	16
6.2	Connecting to uPyxis® Desktop App . . . . .	17
6.3	Information Screen . . . . .	18
6.4	Calibration Screen . . . . .	18
6.5	Diagnosis Screen . . . . .	20
<b>7</b>	<b>Outputs</b>	<b>20</b>
7.1	4–20mA Output Setup . . . . .	20
7.2	Adjusting 4–20mA Span . . . . .	21
7.3	Communication using Modbus RTU . . . . .	21
<b>8</b>	<b>Sensor Maintenance and Precaution</b>	<b>22</b>
8.1	Methods to Cleaning the ST-772 Series Sensor . . . . .	22
8.2	Storage . . . . .	23
<b>9</b>	<b>Troubleshooting</b>	<b>23</b>
<b>10</b>	<b>Contact Us</b>	<b>23</b>

## **Warranty Information**

### **Confidentiality**

The information contained in this manual may be confidential and proprietary and is the property of Pyxis Lab, Inc. Information disclosed herein shall not be used to manufacture, construct, or otherwise reproduce the goods described. Information disclosed herein shall not be disclosed to others or made public in any manner without the express written consent of Pyxis Lab, Inc.

### **Standard Limited Warranty**

Pyxis Lab warrants its products for defects in materials and workmanship. Pyxis Lab will, at its option, repair or replace instrument components that prove to be defective with new or remanufactured components (i.e., equivalent to new). The warranty set forth is exclusive and no other warranty, whether written or oral, is expressed or implied.

### **Warranty Term**

The Pyxis warranty term is thirteen (13) months ex-works. In no event shall the standard limited warranty coverage extend beyond thirteen (13) months from original shipment date.

### **Warranty Service**

Damaged or dysfunctional instruments may be returned to Pyxis for repair or replacement. In some instances, replacement instruments may be available for short duration loan or lease.

Pyxis warrants that any labor services provided shall conform to the reasonable standards of technical competency and performance effective at the time of delivery. All service interventions are to be reviewed and authorized as correct and complete at the completion of the service by a customer representative, or designate. Pyxis warrants these services for 30 days after the authorization and will correct any qualifying deficiency in labor provided that the labor service deficiency is exactly related to the originating event. No other remedy, other than the provision of labor services, may be applicable.

Repair components (parts and materials), but not consumables, provided during a repair, or purchased individually, are warranted for 90 days ex-works for materials and workmanship. In no event will the incorporation of a warranted repair component into an instrument extend the whole instrument's warranty beyond its original term.

### **Warranty Shipping**

A Repair Authorization (RA) Number must be obtained from Pyxis Technical Support before any product can be returned to the factory. Pyxis will pay freight charges to ship replacement or repaired products to the customer. The customer shall pay freight charges for returning products to Pyxis. Any product returned to the factory without an RA number will be returned to the customer. To receive an RMA you can generate a request on our website at <https://pyxis-lab.com/request-tech-support/>.

### **Pyxis Technical Support**

Contact Pyxis Technical Support at +1 (866) 203-8397, [service@pyxis-lab.com](mailto:service@pyxis-lab.com), or by filling out a request for support at <https://pyxis-lab.com/request-tech-support/>.

## 1 Introduction

The Pyxis ST-772 Series dissolved oxygen (DO) sensor is offered in submersible or inline/bypass installation formats and available in 304 stainless steel and CPVC body design options. The sensor design is based on the principle of fluorescence quenching to determine the dissolved oxygen content in water. It incorporates Pyxis' advanced technology in the field of fluorescence detection. The ST-772 Series sensor uses dual light source detection technology with excitation and reference light sources, offering a wide detection range and low detection limit. The sensor integrates temperature and pressure sensors, which can perform temperature and pressure compensation for the measurement of dissolved oxygen based on ambient environmental conditions present in the application of use.

The ST-772 Series sensor offers an easily replaceable, front loading DO membrane cap that has been independently developed by Pyxis Lab, with a typical service life of up to two years. This unique DO membrane cap design incorporates a black microporous PTFE membrane material designed to provide extreme scratch resistance, extended life span and simple replacement. The flat front-end design of the ST-772 Series sensor makes this platform less prone to contamination or fouling and is easy to clean.

The sensor body options of 304 stainless steel and CPVC are well suited for aggressive industrial application use. The ST-772 Series sensor may be utilized in a submersed floating or submersed fixed installation format with the Pyxis installation assembly options. It may also be used in an inline pressurized Tee assembly format (ST-772T and ST-772T-P sensor options). All options are discussed in the **Installation** section. The ST-772 Series offers both 4–20mA and RS-485 Modbus outputs and is Bluetooth enabled when used in conjunction with the MA-CR Bluetooth Adapter.

The ST-772 Series sensor measures the partial pressure of the dissolved oxygen (DO) in water. In most applications, the source of DO is oxygen in the air. In other application such as in aquaculture, the source of DO is photosynthesis. The concentration of dissolved oxygen is a derived value from the measured oxygen partial pressure. The relationship between the DO concentration and the oxygen partial pressure is governed by the law of thermodynamics. The ST-772 Series sensor uses the latest USGS equation to convert the oxygen partial pressure to DO in units of ppm or mg/L. Through setup using the **uPyxis®** Mobile or Desktop App, the ST-772 Series sensor can output the measured oxygen partial pressure in other units such as percentage of oxygen saturation.

## 1.1 Main Features

The ST-772 Series sensor includes the following features:

- 0.004–20 ppm measurement range
- Built-in temperature and pressure sensor with automatic compensation
- Accurate and stable measurement with ultra-low drift
- Built-in transmitter without preamplifier or meter head
- Dual Outputs both 4–20mA isolated signal or RS-485 Modbus
- Long-distance transmission with higher stability & accuracy
- Wireless calibration, diagnostics, and data trend via **uPyxis**® App when used with MA-CR Adapter
- The sensor can be Slope calibrated with air or air saturated water
- Zero-point calibration with 5% Sodium Sulfite solution or Nitrogen gas
- Submersible (ST-772) or Inline (ST-772T) installation versions
- Suitable for dissolved oxygen monitoring of:
  - Activated Sludge
  - Aerated Basin
  - Wastewater & Sewage Processing
  - Chemical & Process Water
  - Domestic Water Applications
  - Filtration Applications
  - Aquaculture
  - Agriculture

## 2 Specifications

**Table 1.** ST-772 and ST-772T Specifications

Specification*	ST-772	ST-772T
Part Number (P/N)	53703	53719
Dissolved Oxygen Range	0.004–20 ppm <i>or</i> 0–200% Saturation <i>or</i> 0–500 mbar PO <sub>2</sub>	
Dissolved Oxygen Resolution	0.01 ppm	
Dissolved Oxygen Accuracy	±1% of reading or ±0.1 ppm	
Method	Blue Light Irradiated Emission Red Light Quenching Excitation	
Response Time	<60 seconds	
DO Membrane Cap Life	2 years	
Calibration	Slope calibration: Air or Air Saturated Water Zero calibration: 5% Sodium Sulfite or Nitrogen Gas	
Outputs	4–20mA Analog Output, RS-485 Digital Output with Modbus protocol	
Installation	<b>Submersed Floating Installation, Submersed Fixed Installation</b>	<b>Pipeline Installation</b>
Cable Length	Attached 10 m/30 ft 8-Pin cable, MA-1.5CR Cable (1.5 m/4.9 ft 8-Pin Female Adapter/Flying Lead)	Attached 1.5 m/4.9 ft 8-Pin cable, MA-1.5CR Cable (1.5 m/4.9 ft 8-Pin Female Adapter/Flying Lead)
Power Supply	22–26 VDC, 0.6 W	
Dimension (L × Dia)	11.65 × 1.32 inch (296 × 33.6 mm)	
Weight †	1.67 lb (760 g)	
Body Material	304 Stainless Steel	
Wet Material	304 Stainless Steel and Polycarbonate	
Operational Temperature	32–113 °F (0–45 °C)	
Pressure	Up to 145 psi (1.0 MPa)	
Enclosure Rating	IP67/IP68	
Regulation	CE	

\* With Pyxis's continuous improvement policy, these specifications are subject to change without notice.

† Cables excluded

**Table 2.** ST-772-P and ST-772T-P Specifications

Specification*	ST-772-P	ST-772T-P
Part Number (P/N)	53720	53721
Dissolved Oxygen Range	0.004–20 ppm <i>or</i> 0–200% Saturation <i>or</i> 0–500 mbar PO <sub>2</sub>	
Dissolved Oxygen Resolution	0.01 ppm	
Dissolved Oxygen Accuracy	±1% of reading or ±0.1 ppm	
Method	Blue Light Irradiated Emission Red Light Quenching Excitation	
Response Time	<60 seconds	
DO Membrane Cap Life	2 years	
Calibration	Slope calibration: Air or Air Saturated Water Zero calibration: 5% Sodium Sulfito or Nitrogen Gas	
Outputs	4–20mA Analog Output, RS-485 Digital Output with Modbus protocol	
Installation	<b>Submersed Floating Installation, Submersed Fixed Installation</b>	<b>Pipeline Installation</b>
Cable Length	Attached 10 m/30 ft 8-Pin cable, MA-1.5CR Cable (1.5 m/4.9 ft 8-Pin Female Adapter/Flying Lead)	Attached 1.5 m/4.9 ft 8-Pin cable, MA-1.5CR Cable (1.5 m/4.9 ft 8-Pin Female Adapter/Flying Lead)
Power Supply	22–26 VDC, 0.6 W	
Dimension (L × Dia)	11.65 × 1.32 inch (296 × 33.6 mm)	
Weight †	0.84 lb (380 g)	
Body Material	CPVC	
Wet Material	CPVC and Titanium	
Operational Temperature	32–113 °F (0–45 °C)	
Pressure	Up to 145 psi (1.0 MPa)	
Enclosure Rating	IP67/IP68	
Regulation	CE	

\* With Pyxis’s continuous improvement policy, these specifications are subject to change without notice.

† Cables excluded



### 3 Unpacking Instrument

Remove the instrument and accessories from the shipping container and inspect each item for any damage that may have occurred during shipping. Verify that all accessory items are included. If any item is missing or damaged, please contact Pyxis Lab Customer Service at [service@pyxis-lab.com](mailto:service@pyxis-lab.com).

#### 3.1 Standard Accessories

##### 3.1.1 ST-772 and ST-772-P Standard Accessories (For Submersed Installations)

The following accessories are included in the ST-772 and ST-772-P sensor packages for submersed installations:

- DCC-1 Dissolved Oxygen Membrane Cap P/N: 53712
- MA-1.5CR Cable (1.5 m/4.9 ft 8-Pin Female Adapter/Flying Lead) P/N: 50746
- MA-CR Bluetooth Adapter for 8-Pin Sensors P/N: MA-CR
- Bluetooth/USB Adapter for use with **uPyxis**® Desktop App P/N: MA-NEB
- User Manual available online at <https://pyxis-lab.com/support/>

##### 3.1.2 ST-772T and ST-772T-P Standard Accessories (For Pipeline Installations)

The following accessories are included in the ST-772T and ST-772T-P sensor packages for pipeline installations:

- Tee Assembly 3/4" NPT (1x Tee, O-ring, and Nut) P/N: ST-001
- DCC-1 Dissolved Oxygen Membrane Cap P/N: 53712
- MA-1.5CR Cable (1.5 m/4.9 ft 8-Pin Female Adapter/Flying Lead) P/N: 50746
- MA-CR Bluetooth Adapter for 8-Pin Sensors P/N: MA-CR
- Bluetooth/USB Adapter for use with **uPyxis**® Desktop App P/N: MA-NEB
- User Manual available online at <https://pyxis-lab.com/support/>

### 3.2 Optional Accessories

The following optional accessories can be ordered at [order@pyxis-lab.com](mailto:order@pyxis-lab.com) or the Pyxis E-Store at <https://pyxis-lab.com/shop/>.

**Table 3.** Optional Accessories

Accessory Name	Part Number (P/N)
MA-CR Bluetooth Adapter For 8-Pin Pyxis Sensors	MA-CR
MA-150-1 Submersion Adapter Ball Float & Mounting Bracket for ST-772 and ST-772-P Floating Submersed Installation	53705
MA-120-B Submersion Pipe & Adapter Mounting Bracket for ST-772 and ST-772-P Fixed Installation	50783
ST-001 Inline Tee Assembly (3/4" FNPT, CPVC)	50704
DCC-1 Dissolved Oxygen Membrane Cap — Replacement	53712
MA-50CR Cable (15 m/50 ft 8-Pin Male/Female Extension Cable)	50743
MA-100CR (30.5 m/100 ft 8-Pin Male/Female Extension Cable)	50744
Pyxis Probe Cleaning Kit	SER-01

## 4 Installation

### 4.1 Submersed Floating Installation

The ST-772 (304SS) and ST-772-P (CPVC) may be installed in a submersed/floating application using the MA-150-1 Submersed Floating Adapter Kit. This kit contains a swiveling conduit mounting bracket and ball float-probe adapter assembly in 1" FNPT. The ST-772 and ST-772-P dissolved oxygen sensors need to be installed as shown in Figure 1. For installation, users only need to purchase the MA-150-1 from Pyxis Lab and may obtain water-tight conduit and cable seal adapter from their supplier of choice. For sensor replacement and maintenance, users only need to pull the MA-150-1 and DO sensor from fixing bracket vertically (upward).

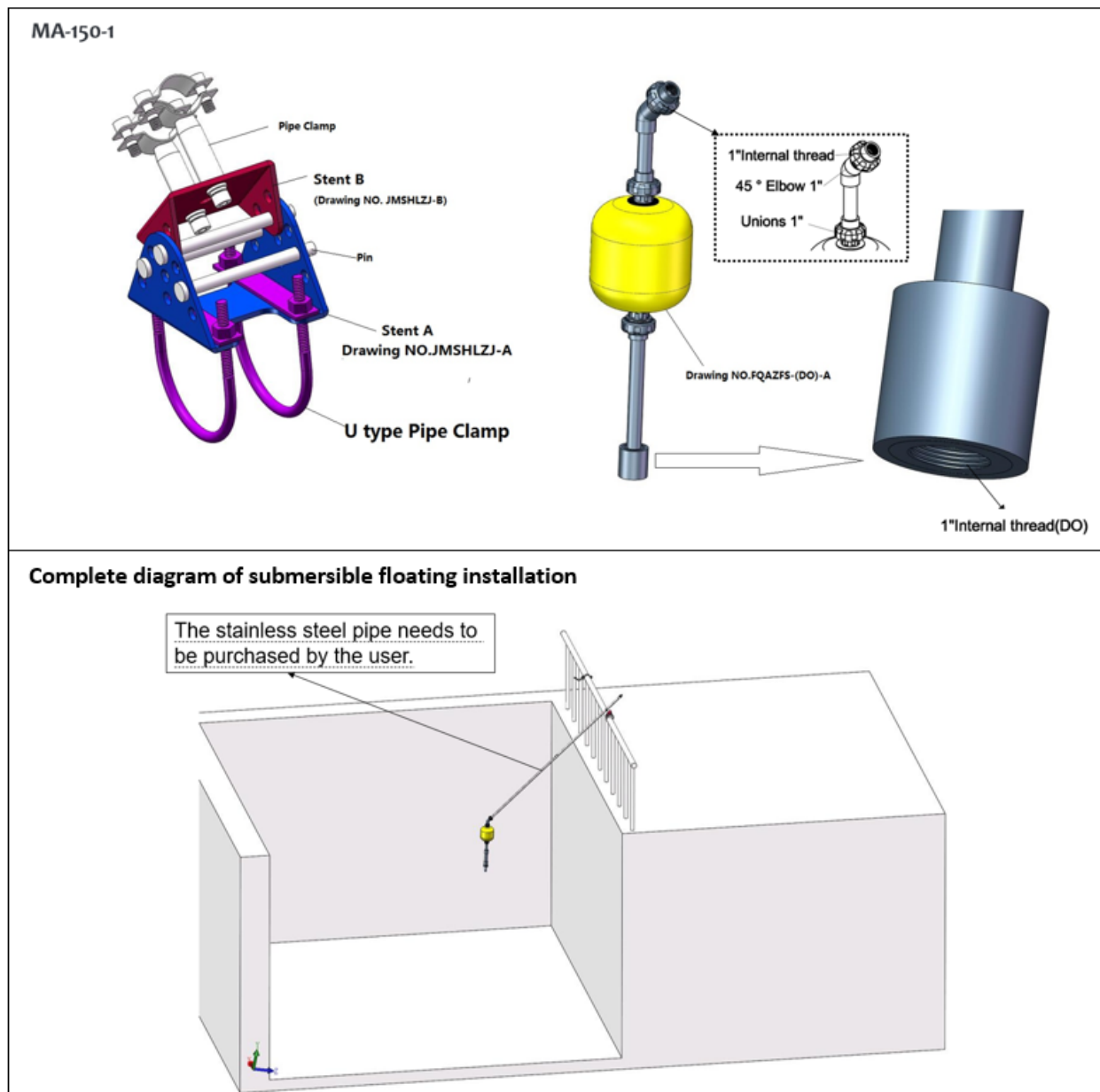

Figure 1. ST-772/ST-772-P in a submersed floating installation

### 4.2 Submersed Fixed Installation

The ST-772 (304SS) and ST-772-P (CPVC) may be installed in a submersed/fixed application using the MA-120-B Submersion Adapter Mounting Bracket and probe adapter coupler in 1" FNPT. The ST-772 and ST-772-P dissolved oxygen sensors need to be installed as shown in Figure 2. For installation, users only need to purchase the MA-120-B from Pyxis Lab and may obtain water-tight conduit and cable seal adapter from their supplier of choice. For sensor replacement and maintenance, users only need to pull the MA-120-B and DO sensor from fixing bracket vertically (upwards).

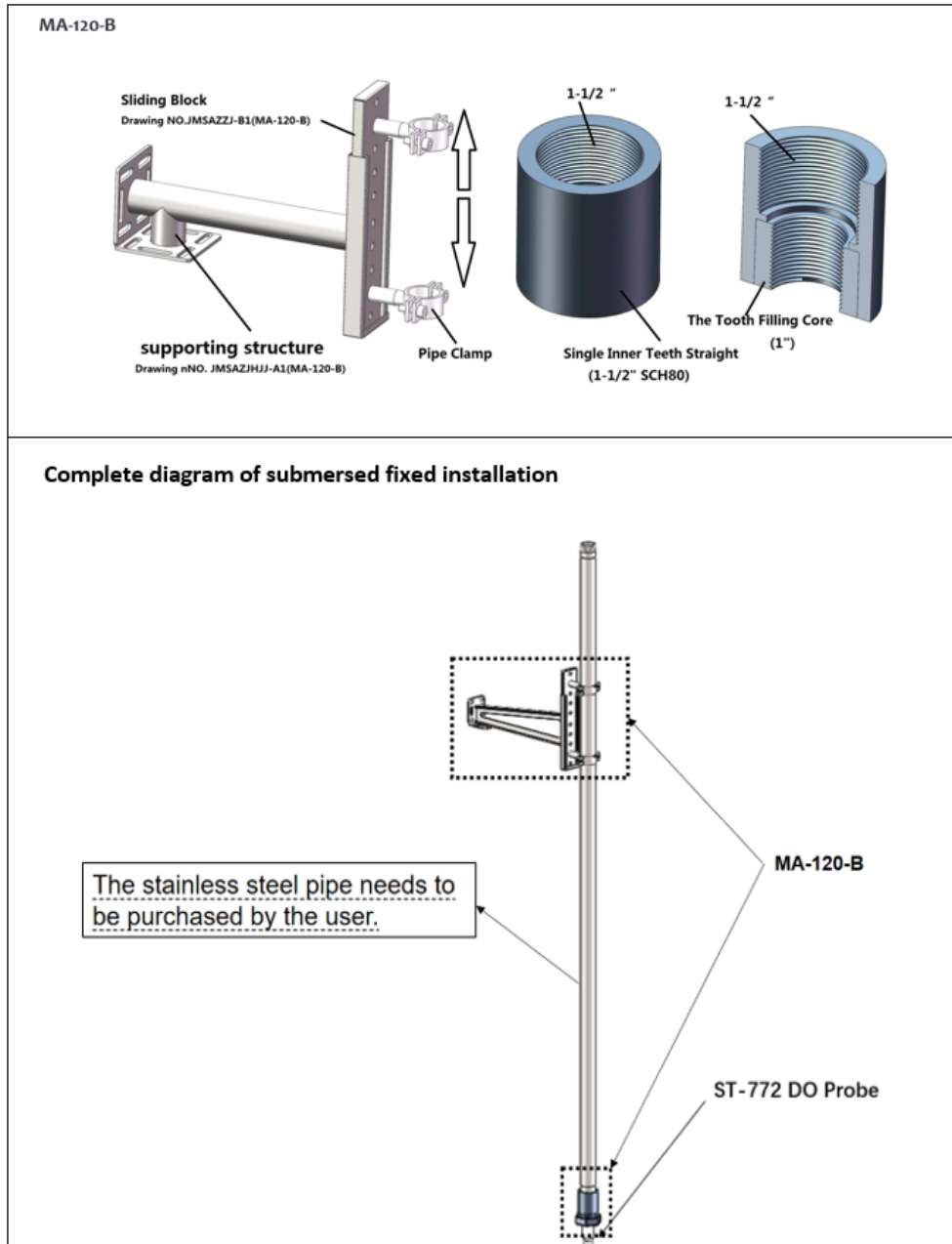

Figure 2. ST-772/ST-772-P in a submersed fixed installation

### 4.3 Pipeline Installation

The ST-772T (304SS) and ST-772T-P (CPVC) sensor may be installed in an inline flow application using the Pyxis ST-001 Inline Tee Assembly. The ST-001 offers 3/4" FNPT thread or socket weld adapters with unions for easy installation and sensor maintenance. Pyxis recommends installation in a vertical flow format from bottom up to reduce the impact of water bubbles. To properly install the ST-772T sensor into the ST-001 Inline Tee Assembly, follow the steps below:

1. Insert the provided O-ring into the O-ring groove on the tee.
2. Insert the ST-772T sensor into the tee.
3. Tighten the tee nut onto the tee to form a water-tight, compression seal.

Ensure the DCC-1 Dissolved Oxygen Membrane Cap is in the direction of water flow as shown in Figure 3.

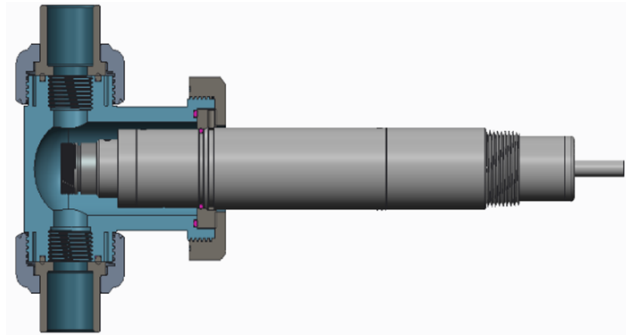

**Figure 3.** ST-772T/ST-772T-P in a pipeline installation using ST-001 Inline Tee Assembly

#### 4.4 Wiring

If the power ground terminal and the negative 4–20mA terminal in the controller are internally connected (non-isolated 4–20mA input), it is unnecessary to connect the 4–20mA negative wire (gray) to the 4–20mA negative terminal in the controller. If a separate DC power supply other than that from the controller is used, make sure that the output from the power supply is rated for 22–26 VDC @ 65 mA.

**\*NOTE\*** *The negative 24V power terminal (power ground) and the negative 4–20mA terminal on the ST-772 Series sensor are internally connected.*

Follow the wiring table below to connect the ST-772 Series sensor to a controller:

**Table 4.**

Wire Color	Designation
Red	24V +
Brown	24V Power ground
Gray*	4–20mA -
White	4–20mA +
Pink	RS-485 C
Blue	RS-485 A
Yellow	RS-485 B
Green	Earth ground
Black	Shield

\* Internally connected to the power ground

#### 4.5 Connecting via Bluetooth

A Bluetooth adapter (P/N: MA-CR) can be used to connect a ST-772 Series sensor to a smart phone with the **uPyxis®** Mobile App or a computer with a Bluetooth/USB Adapter (P/N: MA-NEB) and the **uPyxis®** Desktop App.

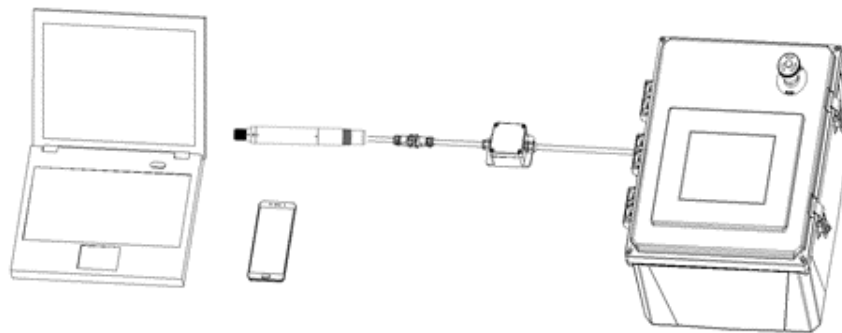

**Figure 4.** Bluetooth connection to ST-772 Series sensor

## 5 Setup and Calibration with uPyxis® Mobile App

### 5.1 Download uPyxis® Mobile App

Download uPyxis® Mobile App from [Apple App Store](#) or [Google Play](#).

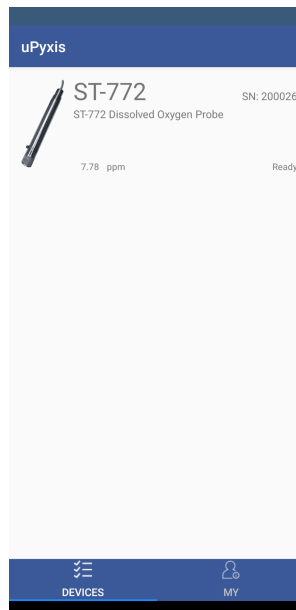

Figure 5. uPyxis® Mobile App installation

## 5.2 Connecting to uPyxis® Mobile App

Connect the ST-772 Series sensor to a mobile smart phone according to the following steps:

1. Open **uPyxis®** Mobile App.
2. On **uPyxis®** Mobile App, pull down to refresh the list of available Pyxis devices.
3. If the connection is successful, the ST-772 Series and its Serial Number (SN) will be displayed (Figure 6).
4. Press on the **ST-772 Series sensor image**.



**Figure 6.**



### 5.3 Calibration Screen and Reading

When connected, the uPyxis® Mobile App will default to the **Calibration** screen. From the **Calibration** screen, you can perform calibrations by pressing on **Zero Calibration**, **Air Calibration**, and **4–20mA Span**.

**\*NOTE\*** Before calibrating, remove the ST-772 Series sensor from the water and wipe it with a damp cloth to remove debris and any biofouling. If there is water on the membrane, dry it with a soft cloth, taking special care not to damage the membrane.

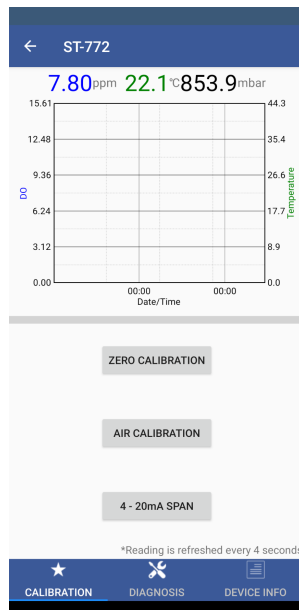

Figure 7.

#### 5.3.1 Zero Calibration

1. Place the sensor in Nitrogen Gas or 5% Sodium Sulfite solution (anaerobic water).
2. Let the ST-772 Series sensor stand for a minimum of 15 minutes. Observe the values being displayed on the **Calibration** screen.
3. Once the displayed oxygen and temperature values are stable, press **Zero Calibration** to perform a zero calibration.
4. If the calibration is successful, the interface will return a message "Calibration Succeeded". If the calibration fails, press **Zero Calibration** again and repeat.

### 5.3.2 Air (Slope) Calibration

1. Place the ST-772 Series sensor in the air with a stable temperature or in air-saturated water.
2. Let the ST-772 Series sensor stand for a minimum of 6 minutes. Observe the values being displayed on the **Calibration** screen.
3. Once the displayed oxygen and temperature values are stable, press **Air Calibration** to perform an air (slope) calibration.
4. Enter the humidity value:
  - If you are using air for calibration, you will need to enter the real-time (current) humidity value.
  - If you are using air-saturated water for calibration, you will need to enter a humidity value of "1".
5. If the air (slope) calibration was successful, the interface will return a message "Calibration Succeeded". If the calibration fails, press **Air Calibration** again and repeat.

### 5.4 Diagnosis Screen

From the **Diagnosis** screen, you can check the diagnosis condition as well as **Export & Upload**. This feature may be used for technical support when communicating with [service@pyxis-lab.com](mailto:service@pyxis-lab.com).

To perform a Cleanliness and Selflife Check, first select the **Diagnosis Condition** which defines the fluid type that the ST-772 Series sensor is currently measuring, then press **Cleanliness and Selflife Check**. If the sensor is clean, a **Clean** message will be shown. If the sensor is severely fouled, a **Please replace the DO membrane cap** message will be shown. In this case, follow the procedure in the **Methods to Cleaning the ST-772 Series Sensor** section of this manual.

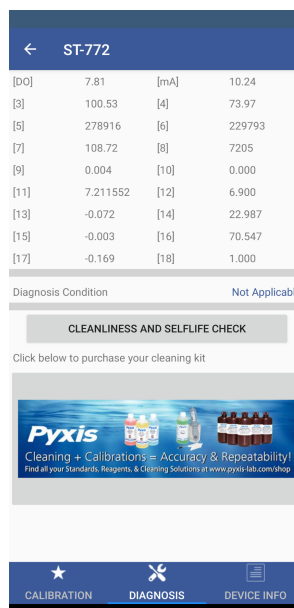

Figure 8.

## 5.5 Device Info Screen

From the **Device Info** screen. You can name the Device or Product as well as set the Modbus address.

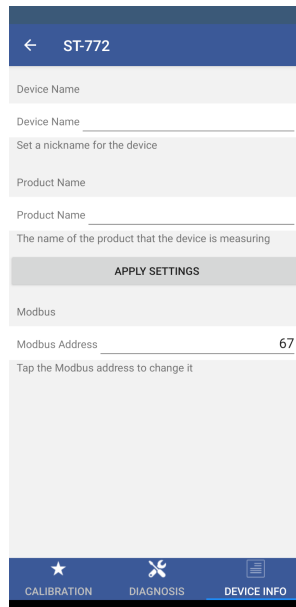

Figure 9.

## 6 Setup and Calibration with uPyxis® Desktop App

### 6.1 Install uPyxis® Desktop App

Download the latest version of **uPyxis®** Desktop software package from: <https://pyxis-lab.com/upyxis/> this setup package will download and install the Microsoft.Net Framework 4.5 (if not previously installed on the PC), the USB driver for the USB-Bluetooth adapter (MA-NEB), the USB-RS485 adapter (MA-485), and the main **uPyxis®** Desktop application. Double click the **uPyxis.Setup.exe** file to install.

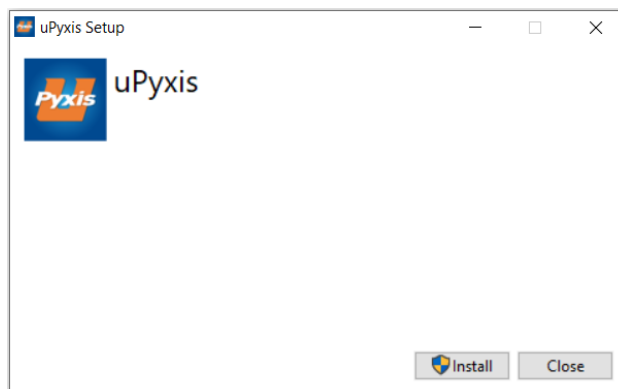

Figure 10. uPyxis® Desktop App installation

Click **Install** to start the installation process. Follow the screen instructions to complete the USB driver and **uPyxis®** installation.

## 6.2 Connecting to uPyxis® Desktop App

Connect the ST-772 Series sensor to a Windows computer using a Bluetooth/USB adapter (P/N: MA-NEB) according to the following steps:

1. Plug the Bluetooth/USB adapter into a USB port in the computer.
2. Launch uPyxis® Desktop App.
3. On uPyxis® Desktop App, click Device → **Connect via USB-Bluetooth** (Figure 11).
4. If the connection is successful, the ST-772 Series and its Serial Number (SN) will be displayed in the left pane of the uPyxis® window.

**\*NOTE\*** After the sensor and Bluetooth is powered up, it may take up to 10 seconds for the adapter to establish the wireless signal for communication.

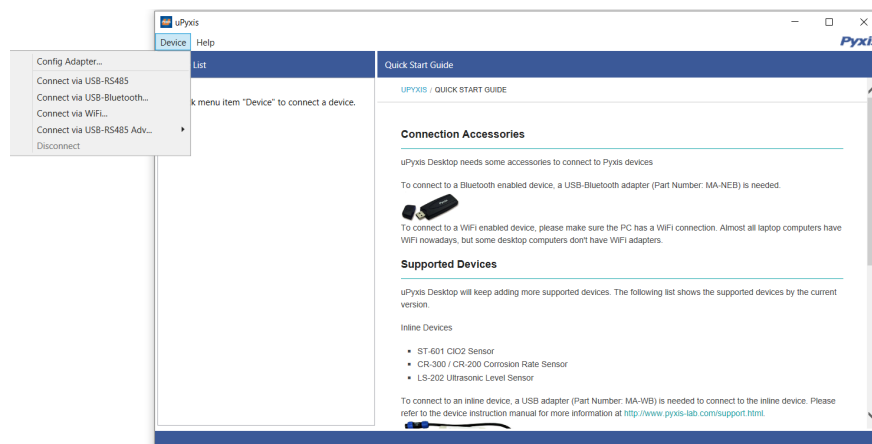

Figure 11.

### 6.3 Information Screen

Once connected to the device, a picture of the device will appear on the top left corner of the window and the uPyxis® Desktop App will default to the **Information** screen. On the **Information** screen you can set the information description for **Device Name**, **Product Name**, and **Modbus Address**, then click **Apply Settings** to save.

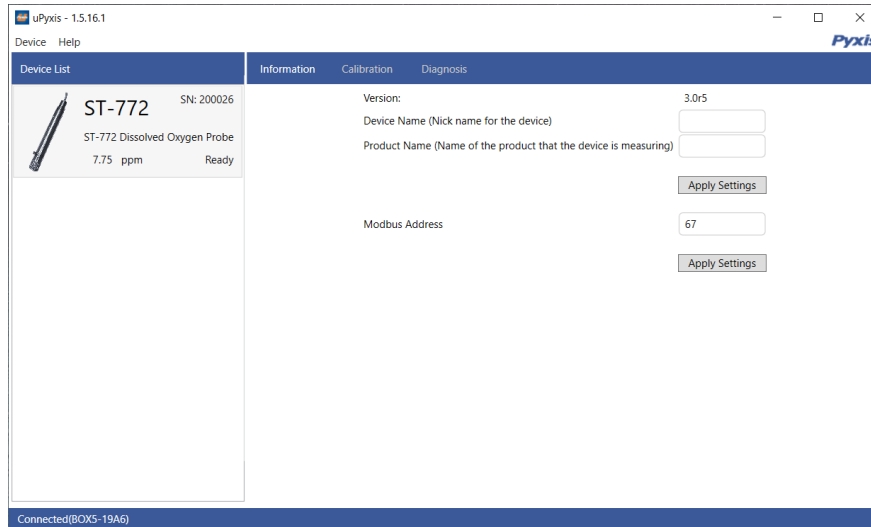

Figure 12.

### 6.4 Calibration Screen

From the **Calibration** screen, you can perform calibrations by pressing on **Zero Calibration**, **Air Calibration**, and **4–20mA Span**.

**\*NOTE\*** Before calibrating, remove the ST-772 Series sensor from the water and wipe it with a damp cloth to remove debris and any biofouling. If there is water on the membrane, dry it with a soft cloth, taking special care not to damage the membrane.

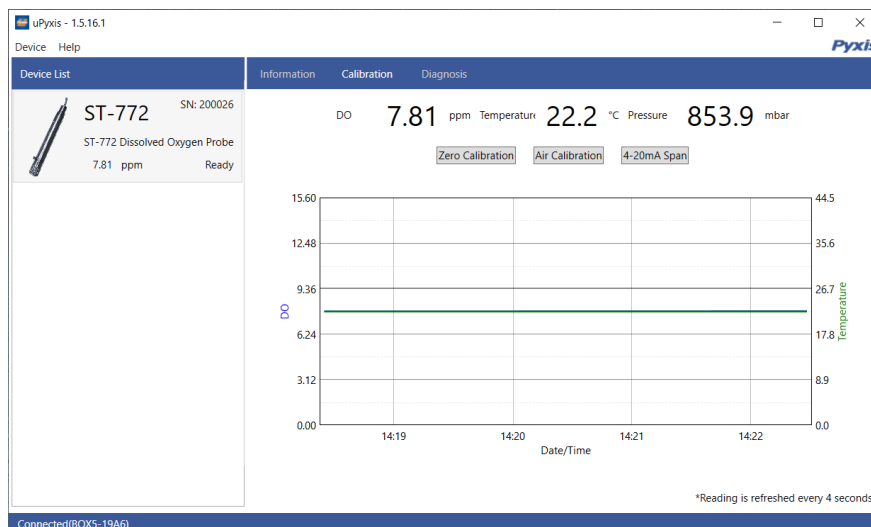

Figure 13.

#### 6.4.1 Zero Calibration

1. Place the sensor in Nitrogen Gas or 5% Sodium Sulfite solution (anaerobic water).
2. Let the ST-772 Series sensor stand for a minimum of 15 minutes. Observe the values being displayed on the **Calibration** screen.
3. Once the displayed oxygen and temperature values are stable, click **Zero Calibration** to perform a zero calibration.
4. If the calibration is successful, the interface will return a message "Calibration Succeeded". If the calibration fails, click **Zero Calibration** again and repeat.

#### 6.4.2 Air (Slope) Calibration

1. Place the ST-772 Series sensor in the air with a stable temperature or in air-saturated water.
2. Let the ST-772 Series sensor stand for a minimum of 6 minutes. Observe the values being displayed on the **Calibration** screen.
3. Once the displayed oxygen and temperature values are stable, click **Air Calibration** to perform an air (slope) calibration.
4. Enter the humidity value:
  - If you are using air for calibration, you will need to enter the real-time (current) humidity value.
  - If you are using air-saturated water for calibration, you will need to enter a humidity value of "1".
5. If the air (slope) calibration was successful, the interface will return a message "Calibration Succeeded". If the calibration fails, click **Air Calibration** again and repeat.

## 6.5 Diagnosis Screen

After the device has been calibrated and installation has been completed, to check diagnosis, click on **Diagnosis**. When in the **Diagnosis** screen you can view the Diagnosis Condition of the device. This feature may be used for technical support when communicating with [service@pyxis-lab.com](mailto:service@pyxis-lab.com). To perform a Cleanliness and Selflife Check, first select the **Diagnosis Condition** which defines the fluid type that the ST-772 Series sensor is currently measuring, then click **Cleanliness and Selflife Check**. If the sensor is clean, a **Clean** message will be shown. If the sensor is fouled, a **Please replace the DO membrane cap** message will be shown. In this case, follow the procedure in the **Methods to Cleaning the ST-772 Series** section of this manual.

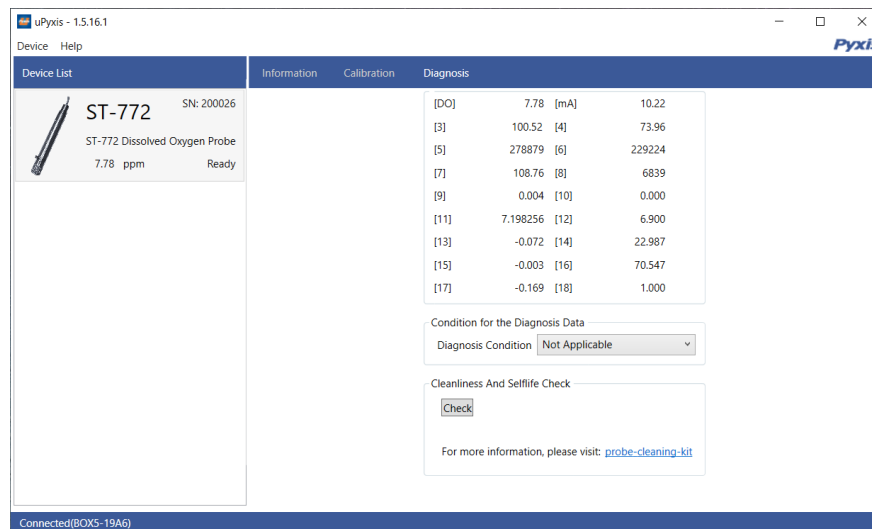

Figure 14.

## 7 Outputs

### 7.1 4–20mA Output Setup

The 4–20mA output of the ST-772 Series sensor is scaled as:

- Dissolved Oxygen:
  - 4 mA = 0 ppm
  - 20 mA = 20 ppm

### 7.2 Adjusting 4–20mA Span

Users may adjust the output scale using 4–20mA Span to change the dissolved oxygen ppm value corresponding to the 20 mA output via uPyxis®. For the uPyxis® Mobile App, press **4-20mA Span** found on the **Calibration and Reading Screen**, shown in Figure 15. For the uPyxis® Desktop App, click **4-20mA Span** found on the **Calibration Screen**, shown in Figure 16.

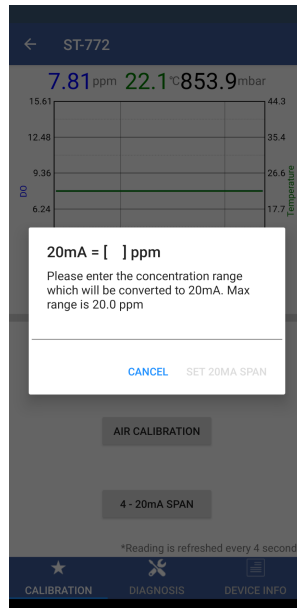

Figure 15.

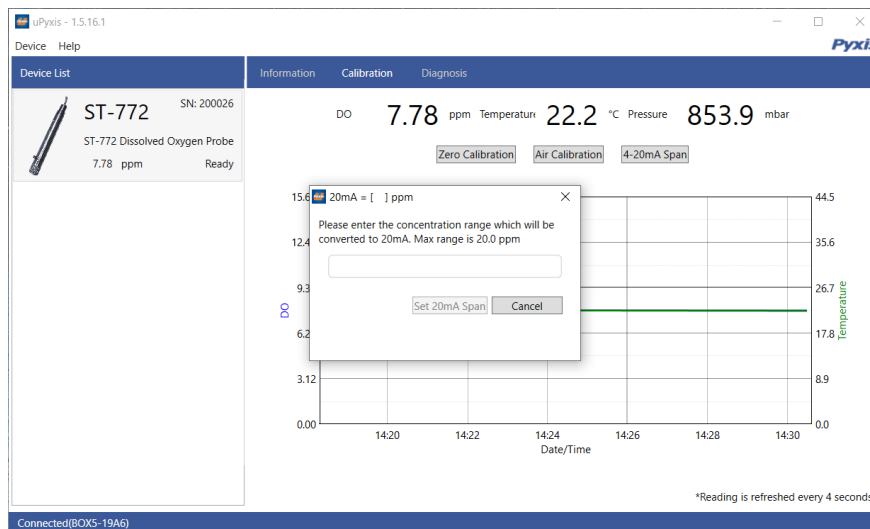

Figure 16.

### 7.3 Communication using Modbus RTU

The ST-772 Series sensor is configured as a Modbus slave device. In addition to the dissolved oxygen ppm value, many operational parameters, including warning and error messages, are available via a Modbus RTU connection. Contact Pyxis Lab Customer Service ([service@pyxis-lab.com](mailto:service@pyxis-lab.com)) for more information.



## 8 Sensor Maintenance and Precaution

The ST-772 Series sensor is designed to provide reliable and continuous dissolved oxygen readings even when installed in moderately contaminated industrial waters. Although the optics are compensated for the effects of moderate fouling, heavy fouling will prevent the light from reaching the sensor, resulting in low readings and the potential for product overfeed if the ST-772 Series sensor is used as part of an automated control system. When used to control product dosing, it is suggested that the automation system be configured to provide backup to limit potential product overfeed, for example by limiting pump size or duration, or by alarming if the pumping rate exceeds a desired maximum limit.

The ST-772 Series sensor is designed to be easily removed, inspected, and cleaned if required. It is suggested that the ST-772 Series sensor be checked for fouling and cleaned/calibrated on a monthly basis. Heavily contaminated waters may require more frequent cleanings. Cleaner water sources with less contamination may not require cleaning for several months. The need to clean the ST-772 Series sensor can be determined by the **Cleanliness and Selflife Check** using either the **uPyxis®** Mobile App (see the **Mobile Diagnosis Screen** section) or the **uPyxis®** Desktop App (see the **Desktop Diagnosis Screen** section). If the **Cleanliness and Selflife Check** continues to return a **Please replace the DO membrane cap**, use an Allen wrench to remove the protective cover, unscrew the current membrane cap, check whether the inside of the ST-772 Series sensor flashes blue and red light, then screw on a new membrane cap and re-fasten the protective cover.

### 8.1 Methods to Cleaning the ST-772 Series Sensor

Any equipment in contact with industrial cooling systems is subject to many potential foulants and contaminants. Our inline sensor cleaning solutions below have been shown to remove most common foulants and contaminants. The surface of the DCC-1 Dissolved Oxygen Membrane Cap can be cleaned with a cotton swab. Please do not use sharp instruments to clean the membrane cap. In addition, the Pyxis Inline Probe Cleaning Solution Kit may also be used to removal of heavy deposits, especially inorganics, and can be purchased at our online E-Store <https://pyxis-lab.com/product/probe-cleaning-kit/>.



**Figure 17.** Inline Probe Cleaning Solution Kit

To clean the ST-772 Series sensor, remove the sensor and the DO membrane cap from the water in use, wipe it with a damp cloth to remove debris and growing organisms, and use a cotton swab dipped in water to clean up the dirt on the membrane surface. Unscrew the membrane cap, check whether the inside of the ST-772 Series sensor flashes blue and red light; after the inspection, screw the DO membrane cap back onto the sensor.

## 8.2 Storage

Avoid long term storage at temperature over 100 °F. Avoid long term storage with the sensor exposed to ambient light as it may reduce the membrane lifetime. In an outdoor installation, properly shield the ST-772 Series sensor from direct sunlight and precipitation.

## 9 Troubleshooting

If the ST-772 Series sensor output signal is not stable and fluctuates significantly, make an additional ground connection — connect the black (shield, earth ground) wire to a conductor that contacts the sample water electrically such as a metal pipe adjacent to the ST-772 Series tee.

## 10 Contact Us

**Pyxis Lab, Inc**

1729 Majestic Dr. Suite 5

Lafayette, CO 80026 USA

[www.pyxis-lab.com](http://www.pyxis-lab.com)

Phone: +1 (866) 203-8397

Email: [service@pyxis-lab.com](mailto:service@pyxis-lab.com)