

# ST-525SS Inline Fluorescein Fluorometer Probe User Manual



March 20, 2020  
Rev. 3.00

**Pyxis Lab, Inc.**  
1729 Majestic Dr. Suite 5  
Lafayette, CO 80026 USA  
[www.pyxis-lab.com](http://www.pyxis-lab.com)

## Table of Contents

<b>1</b>	<b>Introduction</b>	<b>2</b>
<b>2</b>	<b>Specifications</b>	<b>2</b>
<b>3</b>	<b>Unpacking Instrument</b>	<b>3</b>
3.1	Standard Accessories . . . . .	3
3.2	Optional Accessories . . . . .	3
<b>4</b>	<b>Installation</b>	<b>3</b>
4.1	Wiring . . . . .	4
4.2	Connecting via Bluetooth . . . . .	5
4.3	Connecting via USB . . . . .	5
<b>5</b>	<b>Setup and Calibration with uPyxis® Mobile App</b>	<b>5</b>
5.1	Download uPyxis® Mobile App . . . . .	6
5.2	Connecting to uPyxis® Mobile App . . . . .	6
5.3	Calibration Screen and Reading . . . . .	7
5.4	Diagnosis Screen . . . . .	7
5.5	Device Info Screen . . . . .	8
<b>6</b>	<b>Setup and Calibration with uPyxis® Desktop App</b>	<b>8</b>
6.1	Install uPyxis® Desktop App . . . . .	9
6.2	Connecting to uPyxis® Desktop App . . . . .	9
6.3	Information Screen . . . . .	10
6.4	Calibration Screen . . . . .	10
6.5	Diagnosis Screen . . . . .	12
<b>7</b>	<b>Communication using Modbus RTU</b>	<b>12</b>
<b>8</b>	<b>Sensor Maintenance and Precaution</b>	<b>12</b>
8.1	Methods to Cleaning ST Series Probe . . . . .	13
8.2	Storage . . . . .	13
<b>9</b>	<b>Troubleshooting</b>	<b>14</b>
<b>10</b>	<b>Contact Us</b>	<b>14</b>

## Warranty Information

### Confidentiality

The information contained in this manual may be confidential and proprietary and is the property of Pyxis Lab, Inc. Information disclosed herein shall not be used to manufacture, construct, or otherwise reproduce the goods described. Information disclosed herein shall not be disclosed to others or made public in any manner without the express written consent of Pyxis Lab, Inc.

### Standard Limited Warranty

Pyxis Lab warrants its products for defects in materials and workmanship. Pyxis Lab will, at its option, repair or replace instrument components that prove to be defective with new or remanufactured components (i.e., equivalent to new). The warranty set forth is exclusive and no other warranty, whether written or oral, is expressed or implied.

### Warranty Term

The Pyxis warranty term is thirteen (13) months ex-works. In no event shall the standard limited warranty coverage extend beyond thirteen (13) months from original shipment date.

### Warranty Service

Damaged or dysfunctional instruments may be returned to Pyxis for repair or replacement. In some instances, replacement instruments may be available for short duration loan or lease.

Pyxis warrants that any labor services provided shall conform to the reasonable standards of technical competency and performance effective at the time of delivery. All service interventions are to be reviewed and authorized as correct and complete at the completion of the service by a customer representative, or designate. Pyxis warrants these services for 30 days after the authorization and will correct any qualifying deficiency in labor provided that the labor service deficiency is exactly related to the originating event. No other remedy, other than the provision of labor services, may be applicable.

Repair components (parts and materials), but not consumables, provided during a repair, or purchased individually, are warranted for 90 days ex-works for materials and workmanship. In no event will the incorporation of a warranted repair component into an instrument extend the whole instrument's warranty beyond its original term.

### Warranty Shipping

A Repair Authorization (RA) Number must be obtained from Pyxis Technical Support before any product can be returned to the factory. Pyxis will pay freight charges to ship replacement or repaired products to the customer. The customer shall pay freight charges for returning products to Pyxis. Any product returned to the factory without an RA number will be returned to the customer. To receive an RMA you can generate a request on our website at <https://pyxis-lab.com/request-tech-support/>.

### Pyxis Technical Support

Contact Pyxis Technical Support at +1 (866) 203-8397, [service@pyxis-lab.com](mailto:service@pyxis-lab.com), or by filling out a request for support at <https://pyxis-lab.com/request-tech-support/>.

## 1 Introduction

The Pyxis ST-525SS probe uses high temperature-tolerant and humidity-resistant optical filters. It can be operated under a wide range of ambient conditions without the need of humidity and temperature regulation. With this design the performance of the ST-525SS probe can be stable and consistent for an extended period time.

The Pyxis ST-525SS probe measures the concentration of luorescein in water, commonly used as a fluorescent tracer in water treatment applications. The 304-stainless steel body of the ST-525SS probe makes it ideally suited for applications of monitoring boiler feedwater or boiler blowdown after being properly cooled to near the ambient temperature. The 4-20mA current output from the probe can be connected to any controller that accepts an isolated or non-isolated 4-20mA input. The ST-525SS probe is a smart device. In addition to measuring fluorescence, the ST-525SS probe has extra photo-electric components that monitor the color and turbidity of the sample water. This extra feature allows automatic color and turbidity compensation to eliminate interference commonly experienced in real-world applications.

The ST-525SS probe is easy to calibrate using the **uPyxis**® Mobile or Desktop App. Any standard containing Fluorescein in the range of 10 to 60 ppb can be used for the calibration of the ST-525SS. The standard may also be the water sample itself if the Fluorescein concentration of the sample is measured and validated by a calibrated offline fluorometer. This allows the ST-525SS probe to be calibrated online without being removed from the system. The **uPyxis**® App also provides diagnostic information about the ST-525SS probe such as: probe fouling, color or turbidity over range, failure modes, etc. This diagnostic information can also be available via Modbus RTU.

## 2 Specifications

Item	Specification*
P/N	50666
Range	0-60 ppb
Resolution	0.2 ppb
Calibration	Two-point calibration against standard solution
Outputs	4-20mA Analog Output, RS-485 Digital Output with Modbus protocol
Installation	3/4" female NPT threaded ports on the probe itself
Cable Length	5 ft with IP67 connectors
Power Supply	22-26 VDC, 65 mA
Dimension	Length: 8.5 inch (220 mm), Head Cross-Section: 2.25 x 1.75 inch (57.2 x 44.5 mm), Body Diameter: 1.66 inch (42.2 mm)
Weight	2.5 lbs (1130 g)
Material	304 Stainless Steel
Operational Temperature	40-104 °F (4-40 °C)
Storage Temperature	20-140 °F (-7-60 °C)
Pressure	Up to 145 psi (1.0 MPa)
Enclosure Rating	IP67
Regulation	CE

\* With Pyxis's continuous improvement policy, these specifications are subject to change without notice.

### 3 Unpacking Instrument

Remove the instrument and accessories from the shipping container and inspect each item for any damage that may have occurred during shipping. Verify that all accessory items are included. If any item is missing or damaged, please contact Pyxis Lab Customer Service at [service@pyxis-lab.com](mailto:service@pyxis-lab.com).

#### 3.1 Standard Accessories

- 7-Pin Female Adapter/Flying Leads Cable (2 ft) P/N: MA-1100
- User Manual available online at [www.pyxis-lab.com/support.html](http://www.pyxis-lab.com/support.html)

#### 3.2 Optional Accessories











 <b>PYXIS INLINE SENSOR ACCESSORIES - SELECT*A*GUIDE</b> 		
Accessory Name/Description	Part Number	Photo
Pyxis ST Series Cleaning Kit <i>(includes 500mL Sensor Cleaner / Qtips &amp; Pipe Cleaners)</i>	SER-01	
Fluorescein Calibration Standard - 20ppb <i>(500mL Bottle)</i>	FLUO-20	
MA-WB Bluetooth Adapter for All ST Series Sensors <i>(4-20mA &amp; RS-485)</i>	MA-WB	
MA-485 USB Adapter for All ST Series Sensors <i>(4-20mA RS-485)</i>	MA-485	
Bluetooth PC to Handheld Adapter <i>(For uPyxis Firmware Updates)</i>	MA-NEB	
PowerPack 1 <i>(Single Channel Power Supply w/Bluetooth)</i>	MA-BLE-1	
PowerPack 4 <i>(Four Channel Power Supply w/Bluetooth)</i>	MA-BLE-4	
MA-C10 <i>(10' Extension Cable for All ST Sensors)</i>	50738	
MA-C50 <i>(50' Extension Cable for All ST Sensors)</i>	50705	
MA-C100 <i>(50' Extension Cable for All ST Sensors)</i>	50706	

Figure 1.

### 4 Installation

The ST-525SS probe has two 3/4" female NPT ports. It is recommended that two 3/4" NPT to 1/4" tubing adapters are used to connect the probe to the sampling system. Sample water entering the probe must be cooled down to below 104 °F (40 °C). The probe can be held by a 1.75-inch pipe clamp or mounted to a panel with four 1/4-28 bolts. See Figure 2 for ST-525SS dimensions.

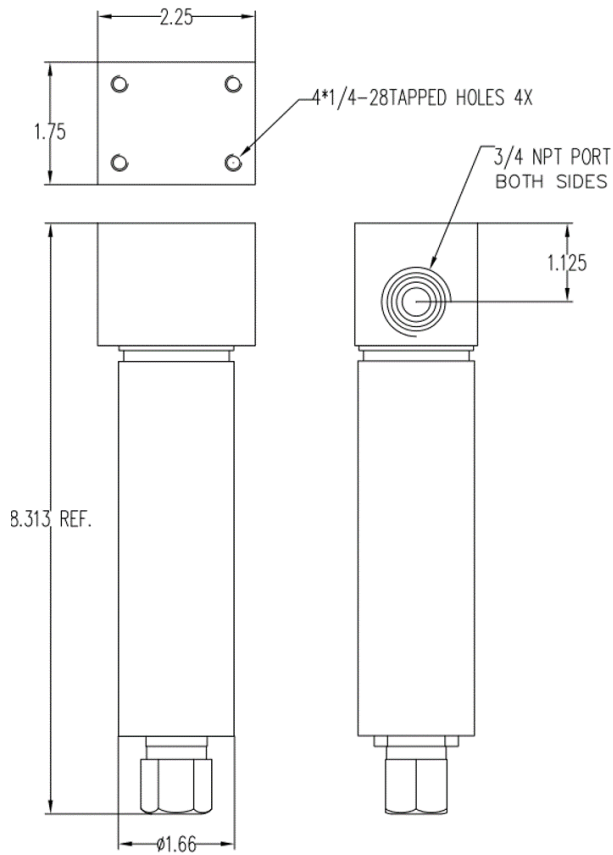

Figure 2. Dimension of the ST-525SS (inch)

#### 4.1 Wiring

If the power ground terminal and the negative 4-20mA terminal in the controller are internally connected (non-isolated 4-20mA input), it is unnecessary to connect the 4-20mA negative wire (green) to the 4-20mA negative terminal in the controller. If a separate DC power supply other than that from the controller is used, make sure that the output from the power supply is rated for 22-26 VDC @ 65mA.

**\*NOTE\*** *The negative 24V power terminal (power ground) and the negative 4-20mA terminal on the ST-525SS probe are internally connected.*

Follow the wiring table below to connect the ST-525SS probe to a controller:

Wire Color	Designation
Red	24V +
Black	24V Power ground
White	4-20mA +
Green*	4-20mA -
Blue	RS-485 A
Yellow	RS-485 B
Clear	Shield, earth ground

\* Internally connected to the power ground

## 4.2 Connecting via Bluetooth

A Bluetooth adapter (P/N: MA-WB) can be used to connect an ST-525SS probe to a smart phone with the **uPyxis®** Mobile App or a computer with the **uPyxis®** Desktop App. The power should be sourced from a 24 VDC power terminal of a controller. If a controller is not available, please purchase a Pyxis PowerPack-1 (MA-BLE-1) or PowerPack-4 (MA-BLE-4) auxiliary power supply with Bluetooth, or an alternative 24 V power supply that can directly connect to the ST-525SS probe with proper cable connectors from Pyxis.

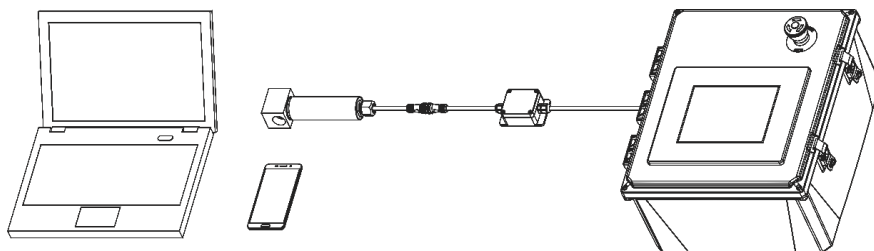

Figure 3. Bluetooth connection to ST-525SS probe

## 4.3 Connecting via USB

A USB-RS485 adapter (P/N: MA-485) can be used to connect an ST-525SS probe to a computer with the **uPyxis®** Desktop App.

**\*NOTE\*** Using non-Pyxis USB-RS485 adapters may result in permanent damage of the ST-525SS probe communication hardware.

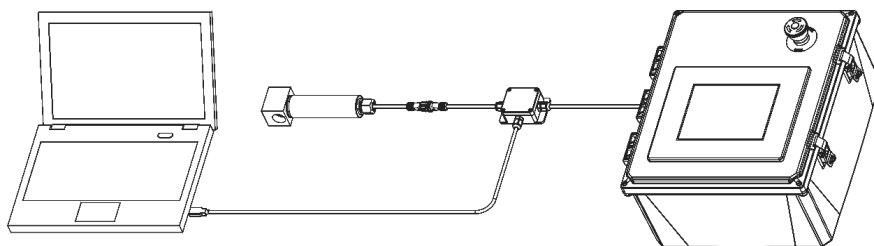

Figure 4. USB connection to ST-525SS probe

## 5 Setup and Calibration with uPyxis® Mobile App

The ST-525SS probe can be calibrated in a two-point (zero + slope) procedure using a deionized water sample and a standard containing 10 to 60 ppb Fluorescein. The calibration solution could be the sample water itself. The concentration of Fluorescein in the sample water can be determined by using a Pyxis SP-360 (P/N: 50207), SP-380 (P/N: 50208), or similar offline fluorometer or calculated from the concentration of any measurable species in the sample water such as polymer, phosphate, or molybdate.

Direct sunlight or indoor light on the ST-525SS probe should be avoided although it is not necessary to completely shield the ST-525SS probe from the ambient light during both the zero point and slope calibrations.

## 5.1 Download uPyxis® Mobile App

Download uPyxis® Mobile App from [Apple App Store](#) or [Google Play](#).

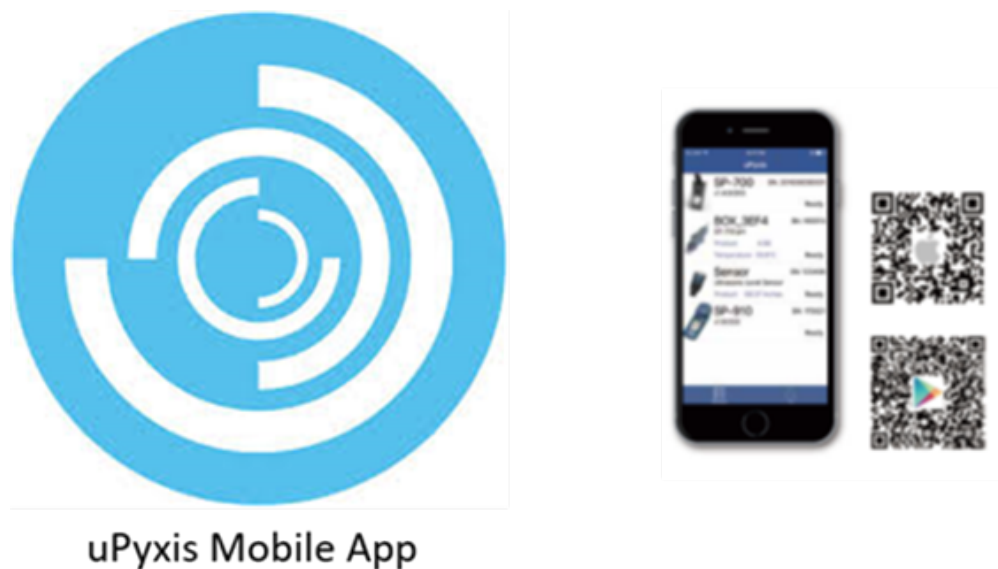

Figure 5.

## 5.2 Connecting to uPyxis® Mobile App

Turn on Bluetooth on your mobile phone (**Do not pair the phone Bluetooth to the ST-525SS probe**). Open uPyxis® Mobile App. Once the app is open the app will start to search for the sensor. Once the uPyxis® Mobile App connects to the sensor, press the **ST-525SS probe**.

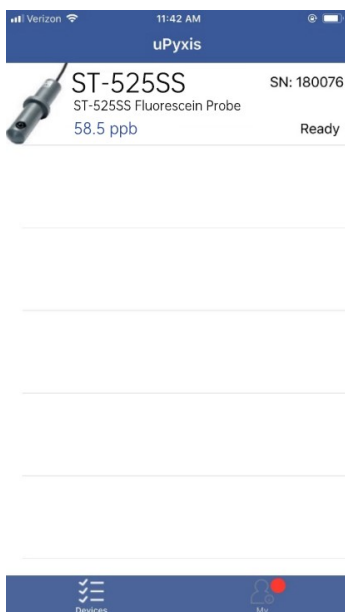

Figure 6.



### 5.3 Calibration Screen and Reading

When connected, the uPyxis® Mobile App will default to the **Calibration** screen. From the **Calibration** screen, you can perform calibrations by pressing on **Zero Calibration**, **Slope Calibration**, and **4-20mA Span**. Follow the screen instructions for each calibration step.



Figure 7.

### 5.4 Diagnosis Screen

From the **Diagnosis** screen, you can check the diagnosis condition as well as **Export & Upload**. This feature may be used for technical support when communicating with [service@pyxis-lab.com](mailto:service@pyxis-lab.com).

To perform a probe cleanliness check, first select the **Diagnosis Condition** which defines the fluid type that the ST-525SS probe is currently measuring, then press **Cleanliness Check**. If the probe is clean, a green **Clean** message will be shown. If the probe is partially fouled, a yellow **Becoming Dirty** message will be shown. If the probe is severely fouled, a red **Dirty** message will be shown. In this case, follow the procedure in the **Methods to Cleaning ST Series Probe** section of this manual.

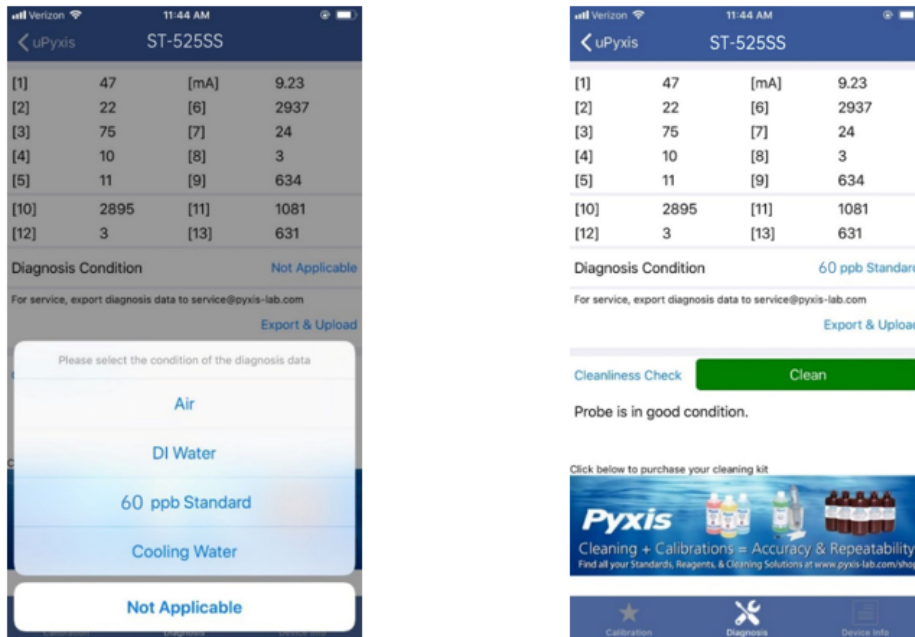

Figure 8.

## 5.5 Device Info Screen

From the **Device Info** screen. You can name the Device or Product.

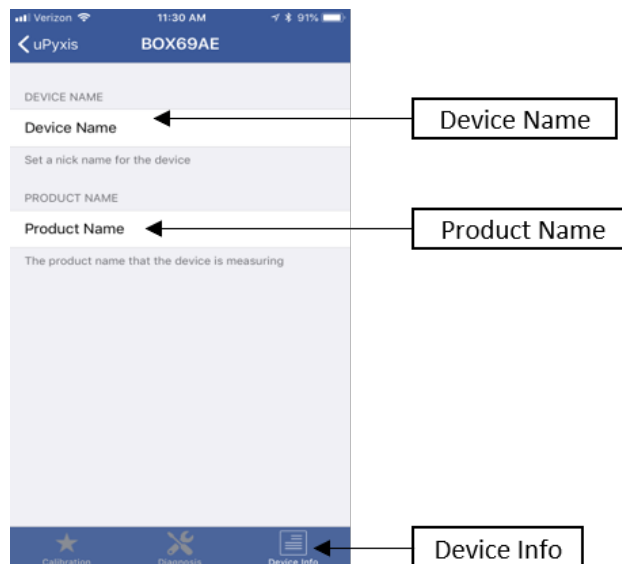

Figure 9.

## 6 Setup and Calibration with uPyxis® Desktop App

The ST-525SS probe can be calibrated in a two-point (zero + slope) procedure using a deionized water sample and a standard containing 10 to 60 ppb Fluorescein. The calibration solution could be the sample water itself. The concentration of Fluorescein in the sample water can be determined by using a Pyxis SP-360

(P/N: 50207), SP-380 (P/N: 50208), or similar offline fluorometer or calculated from the concentration of any measurable species in the sample water such as polymer, phosphate, or molybdate.

Direct sunlight or indoor light on the ST-525SS probe should be avoided although it is not necessary to completely shield the ST-525SS probe from the ambient light during both the zero point and slope calibrations.

## 6.1 Install uPyxis® Desktop App

Download the latest version of **uPyxis®** Desktop software package from: <http://www.pyxis-lab.com/support.html> this setup package will download and install the Microsoft.Net Framework 4.5 (if not previously installed on the PC), the USB driver for the USB-Bluetooth adapter (MA-NEB), the USB-RS485 adapter (MA-485), and the main **uPyxis®** Desktop application. Double click the **uPyxis.Setup.exe** file to install.

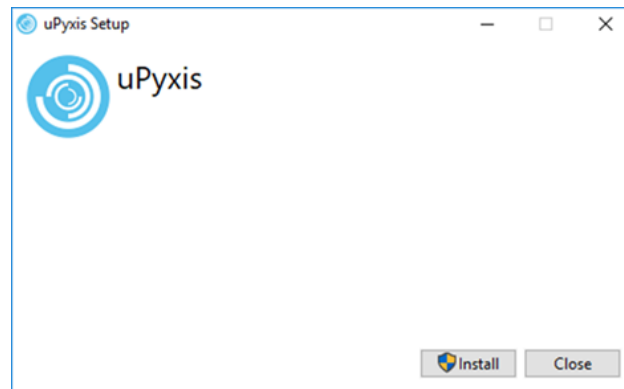

Figure 10.

Click **Install** to start the installation process. Follow the screen instructions to complete the USB driver and **uPyxis®** installation.

## 6.2 Connecting to uPyxis® Desktop App

When the **uPyxis®** Desktop App opens, to find your device, click on **Device**, then **Connect via USB-RS485**.

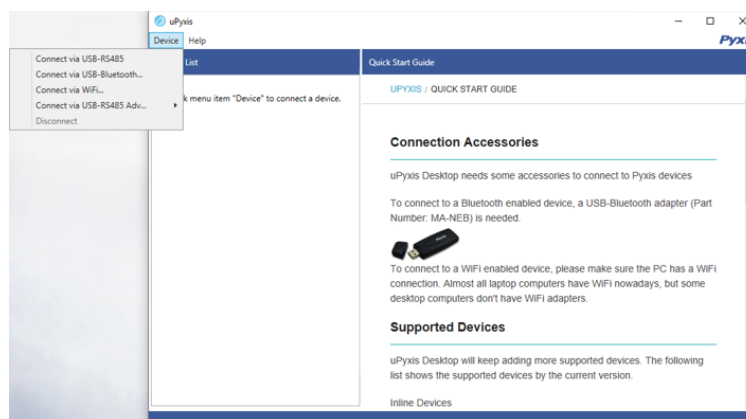

Figure 11.

### 6.3 Information Screen

Once connected to the device, a picture of the device will appear on the top left corner of the window and the **uPyxis**® Desktop App will default to the **Information** screen. On the **Information** screen you can set the information description for **Device Name** and **Product Name**, then click **Set** to save.

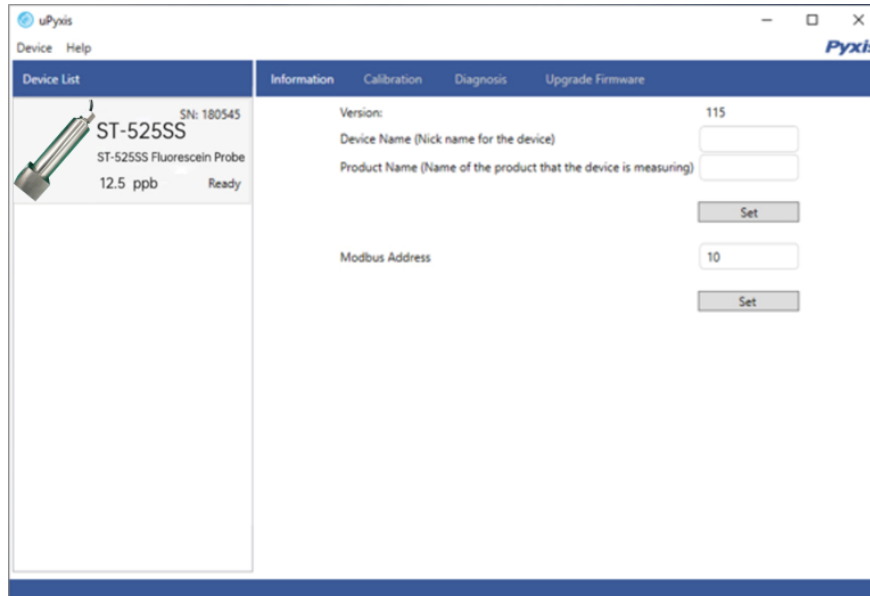

Figure 12.

### 6.4 Calibration Screen

To calibrate the device, click on **Calibration**. On the **Calibration** screen there are three calibration tabs, **Zero Calibration**, **Slope Calibration**, and **4-20mA Span**. The screen also displays the reading of the device. The reading refresh rate is every 4 seconds.



Figure 13.

### 6.4.1 Zero Calibration

To perform Zero Calibration, click on [Zero Calibration](#). Then follow the instruction on how to calibrate, then click [Ok](#).

### 6.4.2 Slope Calibration

To perform Slope Calibration, click on [Slope Calibration](#). Then follow the instruction on how to calibrate, then click [Slope Calibration](#).

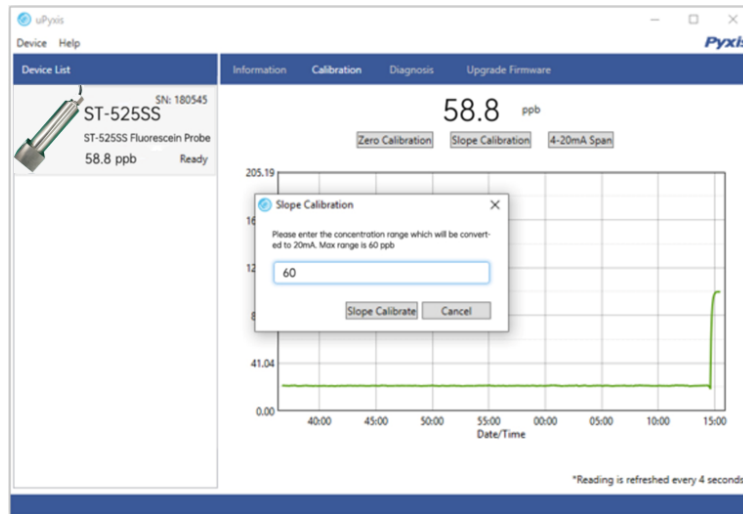

Figure 14.

### 6.4.3 4-20mA Span

To perform 4-20mA Span, click on [4-20mA Span](#). Then follow the instructions provided to alter the 4-20mA output span of the sensor, then click [Set 20mA Span](#). Each sensor format will have a maximum 20 mA range allowed. 4-20mA Span setup must be maintained within the limit of its respective sensor.

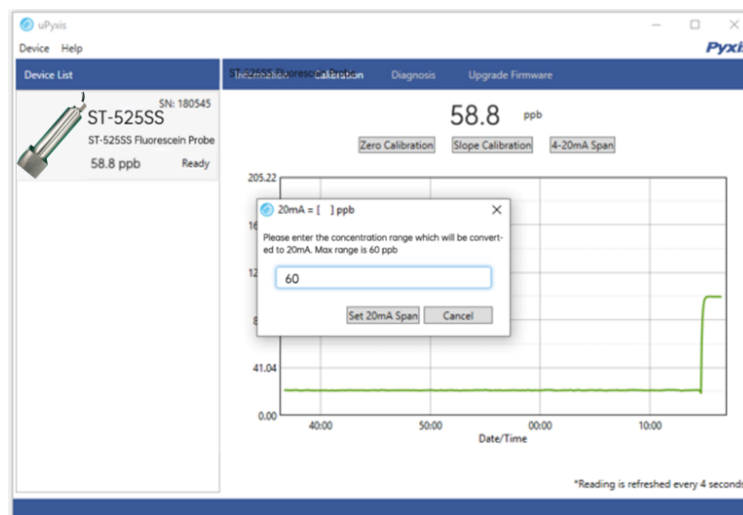

Figure 15.

## 6.5 Diagnosis Screen

After the device has been calibrated and installation has been completed, to check diagnosis, click on **Diagnosis**. When in the **Diagnosis** screen you can view the Diagnosis Condition of the device. This feature may be used for technical support when communicating with [service@pyxis-lab.com](mailto:service@pyxis-lab.com).

To perform a probe cleanliness check, first select the **Diagnosis Condition** which defines the fluid type that the ST-525SS probe is currently measuring, then click **Cleanliness Check**. If the probe is clean, a green **Clean** message will be shown. If the probe is partially fouled, a yellow **Becoming Dirty** message will be shown. If the probe is severely fouled, a red **Dirty** message will be shown. In this case, follow the procedure in the **Methods to Cleaning ST Series Probe** section of this manual.

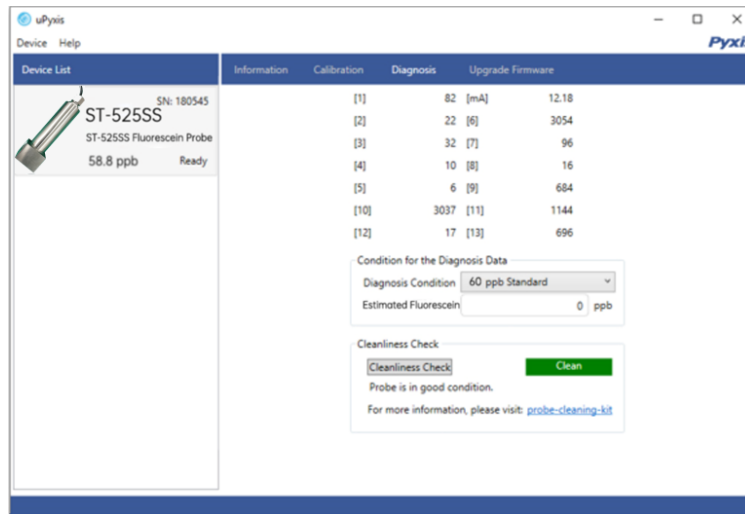

Figure 16.

## 7 Communication using Modbus RTU

The ST-525SS probe is configured as a Modbus slave device. In addition to the ppb Fluorescein value, many operational parameters, including warning and error messages, are available via a Modbus RTU connection. Contact Pyxis Lab Customer Service ([service@pyxis-lab.com](mailto:service@pyxis-lab.com)) for more information.

## 8 Sensor Maintenance and Precaution

The ST-525SS probe is designed to provide reliable and continuous Fluorescein readings even when installed in moderately contaminated industrial cooling waters. Although the optics are compensated for the effects of moderate fouling, heavy fouling will prevent the light from reaching the sensor, resulting in low readings and the potential for product overfeed if the ST-525SS probe is used as part of an automated control system. When used to control product dosing, it is suggested that the automation system be configured to provide backup to limit potential product overfeed, for example by limiting pump size or duration, or by alarming if the pumping rate exceeds a desired maximum limit.

When installed with upstream/downstream compression fittings, the ST-525SS probe is designed to be easily removed, inspected, and cleaned if required. It is suggested that the ST-525SS probe be checked for fouling and cleaned/calibrated on a monthly basis. Heavily contaminated waters may require more frequent cleanings. Cleaner water sources with less contamination may not require cleaning for several

months.

The need to clean the ST-525SS probe can be determined by the **Cleanliness Check** using either the **uPyxis®** Mobile App (see the **Mobile Diagnosis Screen** section) or the **uPyxis®** Desktop App (see the **Desktop Diagnosis Screen** section).

### 8.1 Methods to Cleaning ST Series Probe

Any equipment in contact with industrial cooling systems is subject to many potential foulants and contaminants. Our inline probe cleaning solutions below have been shown to remove most common foulants and contaminants. A small, soft bristle brush, Q-Tips cotton swab, or soft cloth may be used to safely clean the probe housing and the quartz optical sensor channel. These components and more come with a Pyxis Lab **Inline Probe Cleaning Solution Kit** (P/N: SER-01) which can be purchased at our online Estore/Catalog <https://pyxis-lab.com/product/st-series-probe-cleaning-kit/>



Figure 17. Inline Probe Cleaning Solution Kit

To clean the ST series probe, soak the lower half of the probe in 100 mL inline probe cleaning solution for 30 minutes. Rinse the ST series probe with distilled water and then check for the flashing blue light inside the ST series probe quartz tube. If the surface is not entirely clean, continue to soak the ST series probe for an additional 30 minutes. Use the small, soft bristle brush and Q-Tips cotton swabs as necessary to remove any remaining contaminants in the ST series probe quartz tube.

### 8.2 Storage

Avoid long term storage at temperature over 140 °F. In an outdoor installation, properly shield the ST-525SS probe from direct sunlight and precipitation.

## 9 Troubleshooting

If the ST-525SS probe output signal is not stable and fluctuates significantly, make an additional ground connection – connect the clear (shield, earth ground) wire to a conductor that contacts the sample water electrically such as a metal pipe adjacent to the ST-525SS tee.

Carry out routine calibration verification against a qualified Fluorescein standard. After properly cleaning the ST-525SS sensor, carry out the zero point calibration with distilled water and slope calibration using the qualified Fluorescein standard.

## 10 Contact Us

### **Pyxis Lab, Inc**

1729 Majestic Dr. Suite 5

Lafayette, CO 80026 USA

[www.pyxis-lab.com](http://www.pyxis-lab.com)

Phone: +1 (866) 203-8397

Email: [service@pyxis-lab.com](mailto:service@pyxis-lab.com)